





Rostfrei

Inox

Sechskantschrauben

Vis tête hexagonale (6 pans)

DIN 931 / ISO 4014 A2  Seite / Page 33	DIN 931 / ISO 4014 A4  Seite / Page 36	DIN 933 / ISO 4017 A2  Seite / Page 38
DIN 933 / ISO 417 A4  Seite / Page 41		

Metrische Schrauben mit Innen-6-Kt. /

Vis métriques 6 pans creux

DIN 912 / ISO 4762 A2  Seite / Page 45	DIN 912 / ISO 4762 A4  Seite / Page 48	DIN 7984 A2  Seite / Page 50
DIN 7991 / ISO 10642 A2  Seite / Page 51	DIN 7991 / ISO 10642 A4  Seite / Page 54	ISO 7380 A2  Seite / Page 56
DIN 913 / ISO 4026 A2  Seite / Page 58	DIN 914 / ISO 4027 A2  Seite / Page 60	DIN 916 / ISO 4029 A2  Seite / Page 62

Metrische Schrauben mit Schlitz

Vis Métriques à fente

DIN 84 A / ISO 1207 A2  Seite / Page 64	DIN 85 A / ISO 1580 A2  Seite / Page 66	DIN 963 / ISO 2009 A2  Seite / Page 67
SN / VSM 13328 A2  Seite / Page 69	DIN 964 / ISO 2010 A2  Seite / Page 70	Becherschr. / Vis pøelier A2  Seite / Page 71

Metrische Schrauben mit Kreuzschlitz /

Vis Métriques cruciforme

DIN 7985 / ISO 7045 A2  Seite / Page 72	DIN 965 / ISO 7046 A2  Seite / Page 74	DIN 966 A2  Seite / Page 75
---	--	---





Metrische Schrauben mit Torx

Vis Métriques Torx

DIN 7985 TX / ISO 14583 A2  Seite / Page 76	DIN 965 TX / ISO 14581 A2  Seite / Page 78	ISO 7380 TX A2  Seite / Page 80
ISO 14580 TX A2 157  Seite / Page 81	Zylinderschr. Extr.niedrig.Kopf A2  Seite / Page 82	



Sicherheitsschrauben

Vis inviolables



~ DIN 7991 PIN A2  Seite / Page 83	~ DIN 965 PIN A2  Seite / Page 84	~ ISO 7380 PIN A2  Seite / Page 85
~ ISO 7380 TX PIN A2  Seite / Page 86		

Blechschraben

Vis à tôles











DIN 7982 C / ISO 7050 A2  Seite / Page 87	DIN 7981 C / ISO 7049 A2  Seite / Page 89	DIN 7983 C / ISO 7051 A2  Seite / Page 91
DIN 7982 TX / ISO 14586 A2  Seite / Page 92	DIN 7981 TX / ISO 14585 A2  Seite / Page 94	~ DIN 912 Blech. A2  Seite / Page 96

Sicherheitsblechschrauben

~ DIN 7982 Tx PIN A2		Seite / Page	98
~ DIN 7981 Tx PIN A2		Seite / Page	99





Vis à tôles inviolables

Bohrschrauben



















DIN 7504M I4Kt A2		Seite / Page	100
DIN 7504O I4Kt A2		Seite / Page	101
DIN 7504M Pozi A2		Seite / Page	103
DIN 7504O Pozi A2		Seite / Page	104
DIN 7504M Tx A2		Seite / Page	106
DIN 7504K AISI 410		Seite / Page	107
DIN 7504M I4Kt AISI 410		Seite / Page	108
DIN 7504O I4Kt & TX AISI 410		Seite / Page	109 & 110
DIN 7504M TX AISI 410		Seite / Page	111
Flügelbohrschrauben TX Bi-Metal vis auto perç. à ailettes TX		Seite / Page	112

Vis auto-perçuses

Holzschrauben























DIN 571 A2		Seite / Page	112
Span SENK / VBA FRAISÉE A2		Seite / Page	114
Span PAN-HEAD / VBA PAN-HEAD A2		Seite / Page	116
Span LINSENSENK / VBA FRAISÉE BOMBÉE - A2		Seite / Page	117
Span. Cut mit SENK / VBA FRAISÉE CUT A2		Seite / Page	118

Vis à bois

<p>Holzbohr. SENK / Vis bois FRAISÉE auto-perç A2</p>  		<p>Terrassenbausch. LINSENSENK. A2 Vis pour bois dur FRAISÉE BOMBÉE</p> 	
Seite / Page 119		Seite / Page 120	
<p>FM WOOD PRO A2</p> 	<p>DIN 96 A2</p> 	<p>DIN 97 A2</p> 	
Seite / Page 121	Seite / Page 122	Seite / Page 123	
<p>DIN 95 A2</p> 	<p>Ösenschr. / Piton à œil A2</p> 	<p>Scharnier / Penture A2</p> 	
Seite / Page 124	Seite / Page 125	Seite / Page 125	
<p>Spenglerschrauben 3-tlg TX25 / Vis de ferblantier, 3 parties TX 25</p>  <p>A2/CU</p>		 <p>A2</p>	<p>Stockschrauben A2 Vis double filet</p> 
Seite / Page 126	Seite / Page 126	Seite / Page 126	
<p>DIN 975 - 1M A2</p> 	<p>DIN 975 - 1M A4</p> 	<p>DIN 975 - 3M A2</p> 	
Seite / Page 127	Seite / Page 127	Seite / Page 128	
<p>DIN 975 - 3M A4</p> 	<p>DIN 975 Links - 1M A2</p> 	<p>DIN 582 A2</p> 	
Seite / Page 128	Seite / Page 128	Seite / Page 129	
<p>DIN 580 / ~ ISO 3266 A2</p> 	<p>Ringschr. / Vis œillet A2</p> 	<p>DIN 603 / ISO 8677 A2</p> 	
Seite / Page 129	Seite / Page 129	Seite / Page 130	
<p>DIN 316 AM Form. A2</p> 			
Seite / Page 132			

Unterlagscheiben

Rondelles

DIN 125 A / ISO 7089 A2 	DIN 125 A / ISO 7089 A4 	DIN 9021 / ISO 7093 A2 
Seite / Page 133	Seite / Page 133	Seite / Page 134
DIN 9021 / ISO 7093 A4 	DIN 433 / ISO 7092 A2 	DIN 433 / ISO 7092 A4 
Seite / Page 134	Seite / Page 135	Seite / Page 135
DIN 434 / A2 	DIN 435 A2 	DIN 6798-A A2 
Seite / Page 136	Seite / Page 136	Seite / Page 137
DIN 6798-A A4 	NFE 27619 A2 	DIN 137 B A1 
Seite / Page 137	Seite / Page 138	Seite / Page 138
DIN 127 B A1 	DIN 127 B A4 	DIN 7980 A1 
Seite / Page 139	Seite / Page 139	Seite / Page 140
DIN 7980 A4 	DIN 7349 A2 	CARRO A2 
Seite / Page 140	Seite / Page 140	Seite / Page 141
EPDM A2 	RIP LOCK - M A2 	DIN 471 1.4122 
Seite / Page 142	Seite / Page 142	Seite / Page 143
DIN 472 1.4122 	DIN 1481 / ISO 8752 A1 	
Seite / Page 144	Seite / Page 146	

Muttern

Ecrous



DIN 934 / DIN 934 L / ~ ISO 4032 A2  Seite / Page 148	DIN 934 / ~ ISO 4032 A4  Seite / Page 148	DIN 439 / ~ ISO 4035 A2  Seite / Page 149
DIN 439 / ~ ISO 4035 A4  Seite / Page 149	DIN 929 A2  Seite / Page 150	DIN 6923 / ~ ISO 4161 A2  Seite / Page 150
DIN 1587 A2  Seite / Page 151	DIN 1587 A4  Seite / Page 151	DIN 917 A2  Seite / Page 152
DIN 917 A4  Seite / Page 152	DIN 985 A2  Seite / Page 153	DIN 985 A4  Seite / Page 153
DIN 6334 A2  Seite / Page 154	DIN 6334 A4  Seite / Page 154	Hülsenmuttern / Ecrous à douilles A2  Seite / Page 154
DIN 315 A2  Seite / Page 155	DIN 3250/3 A2  Seite / Page 156	

Befestigungstechnik für Dach & Wand

Couverture et Bardage

Bi-Metall

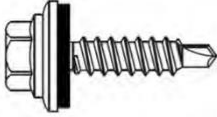
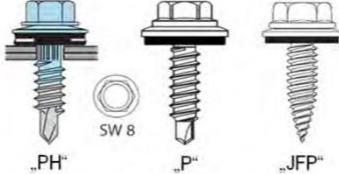
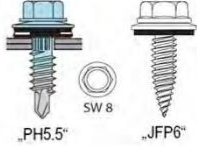
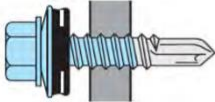
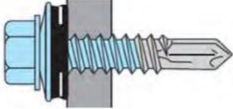
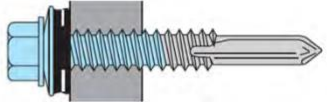
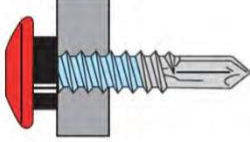
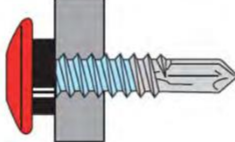
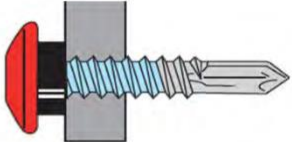
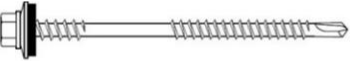

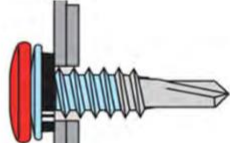
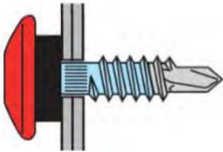
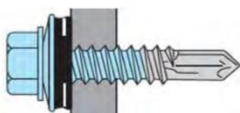
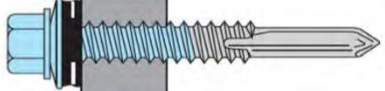
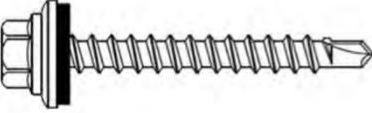
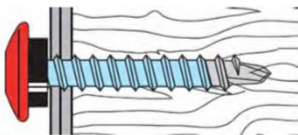
Bi-Métal

<p>DIN 7504K / ISO 15480 + EPDMØ16 A2</p>  <p>Seite / Page 157</p>	<p>Überlappungsschr. Bi-Metall/Vis couturage A2</p>  <p>Seite / Page 157</p>	<p>Längsstossverbindung Bi-Metall A2 Fixation tôle profilée/Bardage</p>  <p>Seite / Page 157</p>
<p>Bi-Metall Bohr./ Vis Auto-perç. Bi-Métal 3 mm A2</p>  <p>Seite / Page 158</p>	<p>Bi-Metall Bohr./ Vis Auto-perç. Bi-Métal 6 mm A2</p>  <p>Seite / Page 158</p>	<p>Bi-Metall Bohr./ Vis Auto-perç. Bi-Métal 12 mm A2</p>  <p>Seite / Page 159</p>
<p>Bi-Metall Bohr./ Vis Auto-perç. Bi-Métal 3 mm - Torx A2</p>  <p>Seite / Page 160</p>	<p>Bi-Metall Bohr./ Vis Auto-perç. Bi-Métal 6 mm - Torx A2</p>  <p>Seite / Page 160</p>	<p>Bi-Metall Bohr./ Vis Auto-perç. Bi-Métal 12 mm - Torx A2</p>  <p>Seite / Page 161</p>
<p>Bi-Metall Bohr./ Vis Auto-perç. Bi-Métal 6 mm - Sandwich A2</p>  <p>Seite / Page 161</p>	<p>Bi-Metall Bohr./ Vis Auto-perç. Bi-Métal 12 mm - Sandwich A2</p>  <p>Seite / Page 162</p>	<p>Bi-Metall Bohr./ Vis Auto-perç. Bi-Métal 2 x 1.25 A2</p>  <p>Seite / Page 159</p>
<p>Bi-Metall Bohr./ Vis Auto-perç. Bi-Métal A2 6 mm</p>  <p>Seite / Page 159</p>	<p>Bi-Metall Bohr./ Vis Auto-perç. Bi-Métal A4 6 mm</p>  <p>Seite / Page 162</p>	<p>Bi-Metall Bohr./ Vis Auto-perç. Bi-Métal A4 12 mm</p>  <p>Seite / Page 162</p>
<p>Bi-Metall Bohr./ Vis Auto-perç. Bi-Métal Für Holz/Pour Bois</p>  <p>Seite / Page 163</p>	<p>Bi-Metall Bohr./ Vis Auto-perç. Bi-Métal Für Holz/Pour Bois</p>  <p>Seite / Page 163</p>	

Stahl Verzinkt

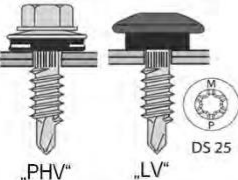
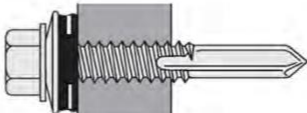
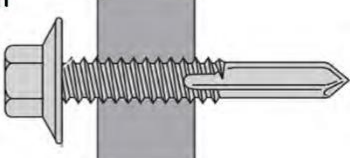



Acier Zingué

<p>Überlappungsschr./Vis de couturage</p>  <p>Seite / Page 164</p>	<p>Bohrschrauben/Vis auto-perçueses Von 1 bis 12 mm - De 1 à 12mm</p>  <p>Seite / Page 165</p>	<p>Bohrschrauben/Vis auto-perçueses 12 mm</p>  <p>Seite / Page 165</p>
---	---	---

Bohr./ Vis Auto-perç. EPDM Ø 19 1.5 bis 6 mm - Sandwich 	Bohr./ Vis Auto-perç. EPDM Ø 19 4 bis 12 mm - Sandwich 
Seite / Page 166	Seite / Page 166

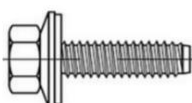
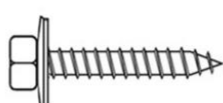











Fassadenschrauben















Vis de Façade

FASSAD. TYP BZ A2 	FASSAD. TYP A A2 	TRESPO A2 
Seite / Page 167	Seite / Page 168	Seite / Page 169
Hakenkopfschrauben Vis de suspension 	Gewindeplatte Plaque pour profilés 	
Seite / page 171	Seite / page 173	

Befestigungstechnik









Fixation

KEM UP 959 Polyester - 300 ml 	KEM UP 941 Vinylester - 420 ml 	KEM UP 943 Vinylester 300 ml 
Seite / Page 175	Seite / Page 176	Seite / Page 177
KEM UP 934 Pur Epoxy 585 ml 	Ankerstangen A2 	Ankerstangen A4 
Seite / Page 178	Seite / Page 179	Seite / Page 180
Zinkspray 	Fettspray/ Lubrifiante 	Genius Spray 
Seite / Page 181	Seite / Page 182	Seite / Page 183
Silikon-Spray/ Spray Silicone 	Reinigungstuch Box/ Lignette nettoyante 	Silikon/ Silicone ONE 40 
Seite / Page 184	Seite / Page 185	Seite / Page 186

Silikon/ Silicone S20 	Silikon/ Silicone S21 	Montageschaum/ Mousse PUR 968 
Seite / Page 187	Seite / Page 188	Seite / Page 189
Montageschaum/ Mousse PUR 962 	Montageschaum/ Mousse G81 	Schaumpistole/ Pistolet 
Seite / Page 190	Seite / Page 191	Seite / Page 192
SIEB / TAMIS 	IG- Hulse für Mörtel Douilles femelles pour mortier 	IG- Hulse für Patrone Douilles femelles pour ampoule 
Seite / Page 192	Seite / Page 193	Seite / Page 197
IG- Hulse für Mörtel Douilles femelles pour mortier 	A4 Bürsten - Ausblaspumpe Brosse - Pompes soufflante 	Ausdruckpistole für Mörtel Pistolet pour Mortier 
Seite / Page 194	Seite / Page 194	Seite / Page 194
Akku-Pistole Pistolet à accu 	Verbundankerpatrone Ampoules chimique 	Ankerstange Tiges d'ancrage 
Seite / Page 196	Seite / Page 197	Seite / Page 198

Bolzenanker

Goujons d'ancrage

FM CRACK Bolzenanker für gerissenen Beton Goujons pour béton fissuré Nautilus 	VZ FM CRACK - OPT. 1 Bolzenanker für gerissenen Beton Goujons pour béton fissuré 	A4 FM 753 - OPT. 7 Kurze + Extra Lange - Ohne CE Court + Extra Long - Sans CE 
Seite / Page 204	Seite / Page 206	Seite / Page 208
FM 753 - OPT. 7 Kurze + Extra Lange - Ohne CE Court + Extra Long - Sans CE 	A4 Innengewinde Bolzenanker Goujon d'ancrage femelle 	VZ Ösenanker Goujons a oeil 
Seite / Page 209	Seite / Page 210	Seite / Page 211
Deckenagel Clous d'ancrage 	VZ Asphaltschraubanker Cheville Fix' Asphalte 	VZ
Seite / Page 211	Seite / Page 210	



Hülsenanker

Cheville à expansion

FM SAFER MP3 evo Hülsenanker Einbruchsicher Cheville à expansion inviolable	VZ
	
Seite / Page	212













Schwerlastanker

Ancrage pour fixation lourdes

ATS evo S Schwerlastanker Cheville fixation lourde	VZ	ATS evo B Schwerlastanker Cheville fixation lourde	VZ	ATS evo SK Schwerlastanker Cheville fixation lourde	VZ
					
Seite / Page	213	Seite / Page	214	Seite / Page	215



Rahmendübel

Cheville pour cadre

TUP 4 Rahmendübel Standard Cheville pour cadre standard	VZ	TUP 4 Rahmendübel Standard Cheville pour cadre standard	A4	TUP 4 SK Rahmendübel Standard Cheville pour cadre standard	A4
					
Seite / Page	216	Seite / Page	217	Seite / Page	217
FM X5 SK Fassadendübel Cheville pour façade	VZ	FM X5 SK Fassadendübel Cheville pour façade	A4	FM X5 Fassadendübel Cheville pour façade	VZ
					
Seite / Page	218	Seite / Page	219	Seite / Page	220
FM X5 Fassadendübel Cheville pour façade	A4	FM X5 small SK Rahmendübel Kurz Cheville Multi-expansion Courte	VZ	FM X5 small Rahmendübel Kurz Cheville Multi-expansion Courte	VZ
					
Seite / Page	221	Seite / Page	222	Seite / Page	223
FM X5 small Rahmendübel Kurz Cheville Multi-expansion Courte	A4	FM SAFER X5 Rahmendübel Einbruchsicher Cheville Multi-expansion anti intrusion	VZ	FM SAFER X5 Rahmendübel Einbruchsicher Cheville Multi-expansion anti intrusion	A4
					
Seite / Page	224	Seite / Page	225	Seite / Page	225

Betonschrauben





Vis béton

Rahmenschrauben SK Vis Béton pour cadre Fraisée	VZ	Rahmenschrauben Zylinder. Vis Béton pour cadre Cylindrique	VZ	FM SAFER Betonschrauben Einbruchsicher Vis béton anti intrusion	VZ
					
Seite / Page	226	Seite / Page	227	Seite / Page	228

<p>FM CLK Betonschr./Vis béton</p>  <p>Seite / Page 229</p>	<p>VZ Betonschrauben 6Kt Kopf mit Flansch Ø8-10-12 Vis Béton tête 6pans avec embase</p>  <p>SW 10</p> <p>Seite / Page 230</p>	<p>Betonschrauben SK Vis Béton tête fraisée</p>  <p>Seite / Page 230</p>
<p>Betonschrauben Rundkopf Vis Béton tête ronde</p>  <p>Ø 17 mm</p> <p>Seite / Page 230</p>	<p>VZ Betonschrauben 6Kt Kopf Vis Béton tête 6pans</p>  <p>Seite / Page 232</p>	<p>A4 Betonschrauben SK Vis Béton tête fraisée</p>  <p>Seite / Page 232</p>





Dübel

Cheilles

<p>TAP Einschlaganker Cheville de frappe</p>  <p>Seite / Page 233</p>	<p>VZ TAP Einschlaganker Cheville de frappe</p>  <p>Seite / Page 234</p>	<p>TO Messing Dübel Cheville Laiton</p>  <p>Seite / Page 235</p>
<p>TML Porenbetondübel Cheville pour béton cellulaire</p>  <p>Seite / Page 235</p>	<p>Nylon</p>	



Nageldübel

Clous-vis

<p>TSS Nageldübel mit Senkkragen Clou-vis col fraisé</p>  <p>Seite / Page 236</p>	<p>VZ TSS Nageldübel mit Senkkragen Clou-vis col fraisé</p>  <p>Seite / Page 237</p>	<p>A2 TPP Nageldübel mit Zyl.Kragen Clou-vis col cylindrique</p>  <p>Seite / Page 238</p>
<p>A2 TPP Nageldübel mit Zyl.Kragen Clou-vis col cylindrique</p> <p>Seite / Page 239</p>	<p>VZ RPI</p>  <p>Seite / Page 247</p>	

Nylondübel

Cheilles Nylon

<p>TU Cheville nylon</p>  <p>Seite / Page 240</p>	<p>Nylon FM XP Mehrzwerckdübel Cheville universelle</p>  <p>Seite / Page 241</p>	<p>Nylon FM TXT Nylondübel Lang Cheville nylon longue</p>  <p>Seite / Page 243</p>
--	--	--

<p>FM X1 Rahmendübel Metrische Schrauben Cheville Multi-expansion Vis Métrique</p> <p>Seite / Page 242</p>	<p>Nylon TUP 3 Lochsteindübel Cheville matériaux creux</p> <p>Seite / Page 244</p>
--	--

Isolierplattendübel

Fixation d'isolant

<p>FM ISOMAX</p> <p>Seite / Page 245</p>	<p>Dämmstoffdübel Thermo Fixations isolations thermiques</p> <p>Seite / Page 248</p>	<p>Dämmhalter Kopf 90mm</p> <p>Seite / Page 249</p>
<p>ISO RG</p> <p>Seite / Page 247</p>	<p>Drall-fix</p> <p>Seite / Page 250</p>	<p>Distansplatten</p> <p>Seite / Page 250</p>

Nieten, Nietmuttern, Nietwerkzeug

Rivet Ecrous sertir, Riveteuse, Outil de rivet

<p>Nieten Flachkopf / Rivet Tête plate</p> <p>Seite / Page 251</p>	<p>Nieten Senkkopf / Rivet Tête fraisée</p> <p>Seite / Page 256</p>	<p>Becher Dichtnieten/ Rivet à tasse</p> <p>Seite / Page 259</p>
<p>Nietmuttern Flachkopf / Ecrous sertir Tête Plate</p> <p>Seite / Page 260</p>	<p>Nietmuttern Senkkopf / Ecrous sertir Tête fraisée</p> <p>Seite / Page 261</p>	<p>Nietwerkzeug outil de rivetage</p> <p>Seite / Page 274</p>
<p>Handwerkzeuge Outil a main</p> <p>Seite / Page 263</p>	<p>Pneumatisches Werkzeug Outil pneumatique</p> <p>Seite / Page 270</p>	



Werkzeug

Outillage

Beton

Béton

<p>Hammerbohrer ROCKET 5 Foret béton SDS+</p> <p>Seite / page 275</p>	<p>Hammerbohrer ROCKET 3 Foret béton SDS+</p> <p>Seite / page 276</p>	<p>Hammerbohrer ROCKET 5 Foret béton SDS Max</p> <p>Seite / page 277</p>
--	--	---

<p>Beton Fräskrone SDS-Max Foret trépan SDS-Max</p>  <p>Seite / page 278</p>	<p>PROConnect Bohrwerkzeuge Outillage PROConnect</p>  <p>Seite / page 280</p>	<p>Meissel Burins</p>  <p>Seite / page 282</p>
<p>Metal Métal</p>		
<p>Spiralbohrer HSS-Co DIN338 Foret HSS-Co DIN338</p>  <p>Seite / page 286</p>	<p>Spiralbohrer HSS-G DIN338 Foret HSS-G DIN338</p>  <p>Seite / page 287</p>	<p>Spiralbohrer HSS-G DIN338 - Turbo Foret HSS-G DIN338 - Turbo</p>  <p>Seite / page 290</p>
<p>Spiralbohrer HSS Foret HSS type N - queue réduite</p>  <p>Seite / page 293</p>	<p>Extra kurzer bohrer HSS-Co DIN1897 Foret extra court HSS-Co DIN1897</p>  <p>Seite / page 294</p>	<p>Spiralbohrer HSS-G - DIN 340 - Lang Foret HSS-G - DIN 340 - Long</p>  <p>Seite / page 295</p>
<p>Holprofilbohrer HSS-G Mèches pour façades HSS-G</p>  <p>Seite / page 296</p>	<p>Spiralbohrer mit Morsekegel HSS Foret cône morse HSS - DIN345</p>  <p>Seite / page 297</p>	<p>Doppelenbohrer HSS-Co + HSS-G Foret double pointe HSS-Co + HSS-G</p>  <p>Seite / page 298</p>
<p>Kegelsenker 90° Fraises coniques à ébavurer</p>  <p>Seite / page 299</p>	<p>Mehrstufenbohrer HSS-G + HSS-Co Fraise étagée HSS-G + HSS-Co</p>  <p>Seite / page 300</p>	<p>Kernbohrer Foret Central</p>  <p>Seite / page 302</p>
<p>Hartmetall-Frässtifte Set Set Fraises Carbure</p>  <p>Seite / page 305</p>	<p>Gewindebohrer HSS-G + HSS-Co Tarauds machine HSS-G + HSS-Co DIN 371/376</p>  <p>Seite / page 306</p>	<p>Schneideisen HSS-G / DIN223B Filière Acier</p>  <p>Seite / page 308</p>
<p>Stichsägeblätter Metall Lames scies sauteuses - Métal</p>  <p>Seite / page 309</p>	<p>Stichsägeblätter Holz/Kunststoff Lames scies sauteuses - Bois/Plastique</p>  <p>Seite / page 314</p>	<p>Säbelsägeblätter Holz/Metall Lames de scies sabre - Bois/Métal</p>  <p>Seite / page 312</p>

Bitz Einsatz
Embouts vis

Seite / page 316

Abrasive

Abrasifs

<p>Stützteller Plateaux supports</p> <p>Seite / page 322</p>	<p>Fiberscheiben Disques Fibre</p> <p>Seite / page 322</p>	<p>Schleiffiberscheiben Disques fibre abrasifs</p> <p>Seite / page 322</p>
<p>Schleiffmopteller/Lamellenscheiben Disques à lamelles</p> <p>Seite / page 323</p>	<p>Schruppscheiben Meules à ébarber</p> <p>Seite / page 323</p>	<p>Trennscheiben Disques à tronçonner</p> <p>Seite / page 324</p>
<p>Diamanttrennscheiben Disques à tronçonner diamantés</p> <p>Seite / page 325</p>		

**Stahl verzinkt (VZ)
Metrische Schrauben**





**Acier zingué (VZ)
Vis Métrique**

<p>DIN 931 / ISO 4014 vz 8.8</p> <p>Seite / Page 326</p>	<p>DIN 933 / ISO 4017 vz 8.8</p> <p>Seite / Page 330</p>	<p>EN 14399-4/-6 fvz 10.9</p> <p>Seite / Page 334</p>
<p>DIN 7990 fvz 4.6</p> <p>Seite / Page 336</p>	<p>DIN 912 / ISO 4762 vz 8.8</p> <p>Seite / Page 338</p>	<p>DIN 7991/ ~ ISO 10642 vz 10.9</p> <p>Seite / Page 341</p>

Holzschrauben







Vis à bois

<p>Span PAN-HEAD / VBA PAN-HEA vz</p> <p>Seite / Page 344</p>	<p>Span SENK / VBA FRAISÉE vz</p> <p>Seite / Page 345</p>	<p>FM WOOD PRO Gelb VZ</p> <p>Seite / Page 347</p>
--	--	---

FM WOOD VBU  Seite / Page 348	Gelb VZ	FM WOOD PRO VXT  Seite / Page 349	Gelb VZ	FM WOOD PRO  Seite / Page 350	Gelb VZ
DIN 571  Seite / Page 350	VZ	Stockschrauben Vis double filet  Seite / Page 352	VZ		







Gewindestangen

Tiges filetées

DIN 975 -1MM  Seite / Page 353	vz 4.6/5.8	DIN 975 --2MM  Seite / Page 354	vz 4.6/5.8	DIN 975 -1MM  Seite / Page 354	vz 5.6
DIN 975 -1MM  Seite / Page 354	vz 8.8	DIN 975 --1MM  Seite / Page 355	vz 10.9 + fvz 10.9	DIN 975 -2MM  Seite / Page 355	vz 8.8

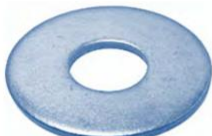
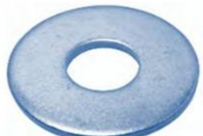

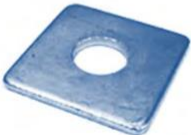
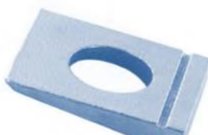

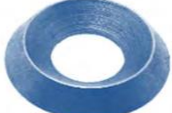

Unterlagscheiben

Rondelles

DIN 125 A / ISO 7089  Seite / Page 356	vz	DIN 125 A / ISO 7089  Seite / Page 356	fvz	DIN 9021 / ISO 7093  Seite / Page 357	vz
STARK / FORTES  Seite / Page 357	vz	CARRO  Seite / Page 358	vz	DIN 7989 A  Seite / Page 359	fvz
DIN 436  Seite / Page 359	vz	DIN 435  Seite / Page 360	fvz	DIN 434  Seite / Page 360	fvz
DIN 127 B  Seite / Page 361	vz	SN 213912  Seite / Page 316	vz		

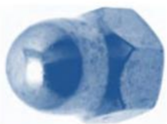

Muttern

Ecrous

DIN 582  Seite / Page 362	vz C15 DIN 580 / ~ISO 3266  Seite / Page 362	DIN 985  Seite / Page 363	vz 8
DIN 6334  Seite / Page 364	vz DIN 934 / ISO 4032  Seite / Page 365	DIN 934 / ISO 4032  Seite / Page 365	fvz
DIN 929  Seite / Page 366	blank / brut DIN 1587  Seite / Page 367		vz







Blechschauben

Vis à toles

DIN 7981 TX / ISO 14586 C  Seite / Page 370	vz DIN 7982 TX / ISO 14585 C  Seite / Page 368
--	--

Bohrschrauben

Vis auto-perçuses

Flügelbohrschrauben TX vis auto perç. à ailettes TX  Seite / Page 371	vz DIN 7504 M TX / ISO 15481  Seite / Page 372	DIN 7504O TX / ISO 15482  Seite / Page 373	vz
DIN 7504K / ISO 15480  Seite / Page 374	vz DIN 7504M Pozi  Seite / Page 375	DIN 7504O Pozi  Seite / Page 377	vz

**Ankerschienen-
schrauben
und Gewindeplatte**

**Vis de suspension et plaques
pour profilés**

Auf Anfrage





Sur demande

Von M 8 bis M 20

Rostfrei A4 / Stahl verzinkt

De M 8 à M 20.

Inox A4 / Acier zingué

Typ	50/30	40/22	38/17	28/15
Form bzw. Kopflänge				
für Profile	52/34, 50/40, 50/30, 49/30, 486	40/25, 40/22	38/17, 36/36, 38/45, 36/20	28/12, 28/15, 28/28, 28/38, 26/26, 26/18

